

































COLORI OPACHI/MATT COLORS

 Bianco matt [01]	 Nero matt [03]	 Nuvola matt [06]	 Napoli matt [13]
 Ambra matt [14]	 Velato matt [09]	 Dune matt [15]	 Bacco matt [16]
 Basento matt [08]	 Lava matt [17]	 Tempesta matt [07]	 Tornado matt [19]
 Oceano matt [10]	 Bianco Assoluto [11]	 Nero Assoluto [12]	 Laguna matt [05]

COLORI LUCIDI/GLASSY COLORS

 Bianco glossy [00]	 Nero glossy [02]	 Nuvola glossy [20]	 Napoli glossy [21]
 Zolfo glossy [22]	 Ambra glossy [23]	 Velato glossy [24]	 Dune glossy [25]
 Bacco glossy [26]	 Basento glossy [27]	 Tornado glossy [28]	 Oceano glossy [29]
 Laguna glossy [30]	 Regale glossy [31]		

Installazione <i>Installation</i>		Scarico a terra <i>Floor drainage</i>	Dimensioni <i>Dimensions</i>		40 x 50 x 90h cm
Troppopieno <i>Overflow</i>		Senza troppopieno <i>Without overflow</i>	Peso <i>Weight</i>		40,00 kg
Piletta <i>Drain</i>		Scarico libero 8 cm <i>Freeflow 8cm</i>	Capienza vasca <i>Tank capacity</i>		15,50 Lt
Smaltatura <i>Enamelled</i>		4 Lati <i>4 Sides</i>	Fissaggi <i>Hardware</i>		Inclusi <i>Included</i>

Lavabo freestanding in ceramica con scarico a parete/terra senza troppopieno, quattro lati smaltati. Piletta esclusa.

Freestanding ceramic washbasin with wall or floor drainage without overflow. Four enamelled sides. Drain not included.

CE EN 14688 - CL00

Sezione A-A
Section A-A

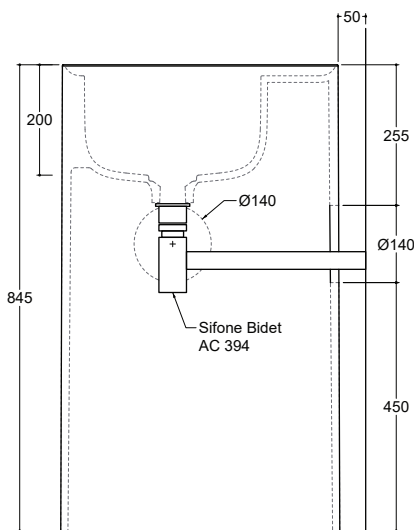

CML 13

Sezione A-A
Section A-A

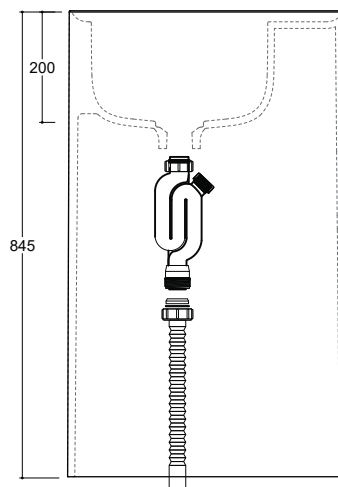

CML 12

Vista superiore
Top view

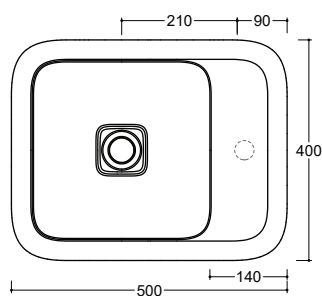

NB le misure indicate possono subire una variazione dello 0,8 % circa, dovuta ad un'usura degli stampi o a piccole variazioni delle caratteristiche tecniche relative alle materie prime che compongono l'impasto.
NB Dimensions shown are subject to a variation of about 0,8 %, due to wear of molds or because of small changes in the technical specification of the raw materials of the dough.
© Copyright Valdama Srl - è vietata la copia, la pubblicazione e la riproduzione anche parziale non autorizzata. Copying, publication and even partial unauthorized reproduction is prohibited.

ATTENZIONE le quote di installazione si riferiscono ad un impianto standard, sono generiche ed indicative. Si consiglia di adattare le quote in base alle esigenze del cliente.

ATTENTION the installation sheets refer to a standard system, they are generic and indicative. We recommend adapting the dimensions according to customer needs.

www.valdama.it Via Galileo Galilei, 5 - 01033 - Civita Castellana (VT) ITALY info@valdama.it